

Operating Instructions

FRIDGE

GB

English,1

SAN 300

SAAN 300

SAN 400

SAN 400 S

Contents

Installation, 2-3

Positioning and connection
Reversible doors

Description of the appliance, 5

Overall view

Accessories, 6

Start-up and use, 7-8

Starting the appliance
Chiller system
Using the refrigerator to its full potential
Food hygiene

Maintenance and care, 9

Switching the appliance off
Cleaning the appliance
Avoiding mould and unpleasant odours
Defrosting the appliance
Replacing the light bulb

Precautions and tips, 10

General safety
Disposal
Respecting and conserving the environment

Troubleshooting, 11

Assistance, 12

GB



Installation

GB

! Before placing your new appliance into operation please read these operating instructions carefully. They contain important information for safe use, for installation and for care of the appliance.

! Please keep these operating instructions for future reference. Pass them on to possible new owners of the appliance.

Positioning and connection

Positioning

1. Place the appliance in a well-ventilated humidity-free room.
2. Do not obstruct the rear fan grills. The compressor and condenser give off heat and require good ventilation to operate correctly and save energy.
3. Leave a space of at least 10 cm between the top part of the appliance and any furniture above it, and at least 5 cm between the sides and any furniture/side walls.
4. Ensure the appliance is away from any sources of heat (direct sunlight, electric stove, etc.).
5. In order to maintain the correct distance between the appliance and the wall behind it, fit the spacers supplied in the installation kit, following the instructions provided.

Levelling

1. Install the appliance on a level and rigid floor.
2. If the floor is not perfectly horizontal, adjust the refrigerator by tightening or loosening the front feet.

Electrical connections

After the appliance has been transported, carefully place it vertically and wait at least 3 hours before connecting it to the electricity mains. Before inserting the plug into the electrical socket ensure the following:

- The appliance is earthed and the plug is compliant with the law.
- The socket can withstand the maximum power of the appliance, which is indicated on the data plate located on the bottom left side of the fridge (e.g. 150 W).
- The voltage must be in the range between the values indicated on the data plate located on the bottom left side (e.g. 220-240V).
- The socket is compatible with the plug of the appliance. If the socket is incompatible with the plug, ask an authorised technician to replace it (see *Assistance*). Do not use extension cords or multiple sockets.

! Once the appliance has been installed, the power supply cable and the electrical socket must be easily accessible.

! The cable must not be bent or compressed.

! The cable must be checked regularly and replaced by authorised technicians only (see *Assistance*).

! The manufacturer declines any liability should these safety measures not be observed.

Your appliance is supplied with a 13amp fused plug that can be plugged into a 13amp socket for immediate use. Before using the appliance please read the instructions below.

WARNING:
THIS APPLIANCE MUST BE EARTHED.

Replacing fuse covers:

When replacing a faulty fuse, a 13amp ASTA approved fuse to BS 1362 should always be used and the fuse cover re-fitted.

If the fuse cover is lost, the plug must not be used until a replacement is obtained.

Replacement fuse covers:

If a replacement fuse cover is fitted, it must be of the correct colour as indicated by the coloured marking or the colour that is embossed in words on the base of the plug.

Changing the plug:

Removing the plug

If your appliance has a non-rewireable moulded plug and you should wish to remove it to add a longer cable or to re-route the mains cable through partitions, units etc. please ensure that either:

- The plug is replaced by a fused 13amp re-wireable plug bearing the BSI mark of approval.

or

- The mains cable is wired directly into a 13amp cable outlet, controlled by a switch (in compliance with BS 5733) which is accessible without moving the appliance.

Disposing of the plug

Cut off and dispose of the supplied plug if it does not fit your socket. The cable should be cut as close as possible to the moulded plug.

Remove the fuse.

WARNING:
To avoid a shock hazard do not insert the discarded plug into a socket anywhere else.

Fitting a new plug

IMPORTANT:

WIRES IN THE MAINS LEAD ARE COLOURED IN ACCORDANCE WITH THE FOLLOWING CODE...

Green and Yellow	- Earth
Blue	- Neutral
Brown	- Live

As the colours of the wires in the mains lead may not correspond with the coloured markings identifying the terminals in your plug, proceed as follows:

- Connect Green and Yellow wire to terminal marked 'E' or  or coloured Green and Yellow.
- Connect Brown wire to terminal marked 'L' or coloured red or brown.
- Connect Blue wire to terminal marked 'N' or coloured Black or Blue.

If a 13amp plug (BS 1363) is used it must be fitted with a 13amp fuse.

If you are in any doubt about the electrical supply to your machine, consult a qualified electrician before use.

CE Marking certifies that this appliance conforms to the following EEC directives :
Low Voltage Equipment - 73/23/EEC & 93/68 EEC
Electromagnetic Compatibility 89/336/EEC, 92/31/EEC & 93/68/EEC

Reversible doors

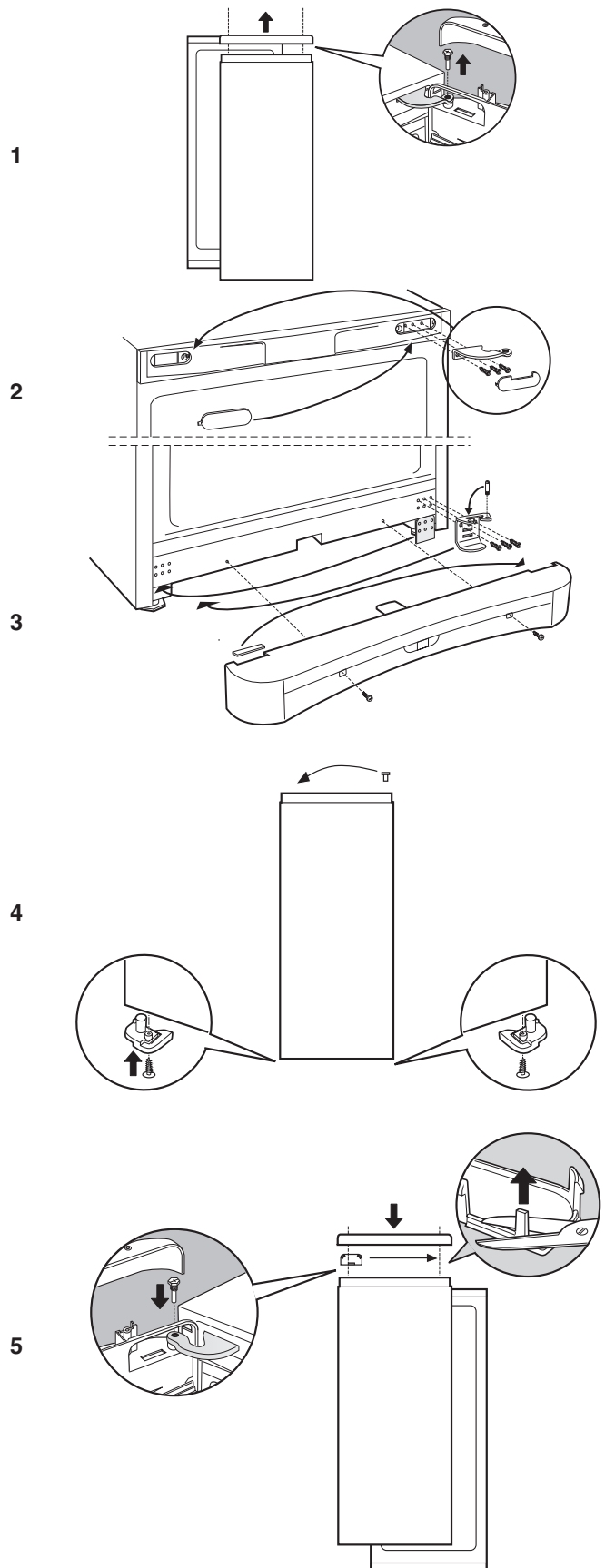

Stability bracket (Models SAN400 and SAN400S only):

WARNING: To prevent the fridge from tilting forwards, it must be held in place with the stability bracket supplied. This is the responsibility of the customer.

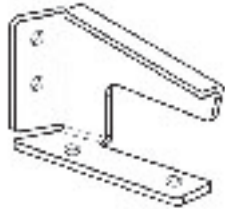

Fixed to the floor or wall at the rear of the fridge, the stability bracket hooks onto the compressor mounting plate holding the fridge secure.

The stability bracket must be installed securely in accordance with these instructions BEFORE using the fridge.

Note: *The fridge is heavy so care must be taken when moving it.*

1. Position the fridge in its chosen location.
2. Looking from the front of the fridge, mark the position of the left hand panel.
3. Move the fridge far enough away to get clear access to the back wall.
4. In order to clear components on the compressor mounting plate, the stability bracket must be positioned on the floor between 100 - 200mm to the right of the left hand panel mark.
5. Mark and drill the fixing holes and insert suitable fixings to hold the bracket firm.
6. Carefully re-position the fridge. Make sure that the compressor mounting plate locates into the stability bracket.

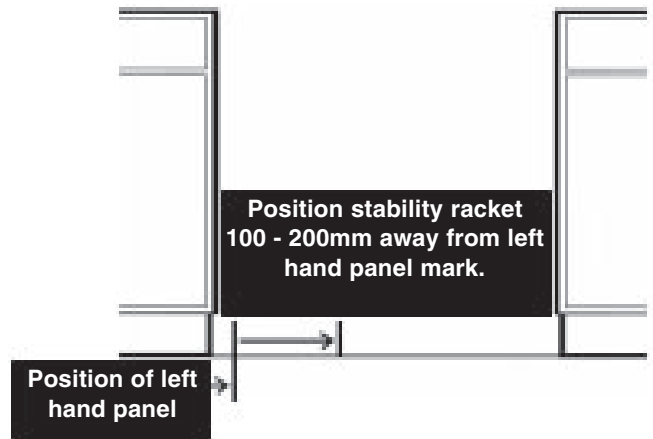

Description of the appliance

Overall view

GB

The instructions contained in this manual are applicable to different model refrigerators. The diagrams may not directly represent the appliance purchased. For more complex features, consult the following pages.

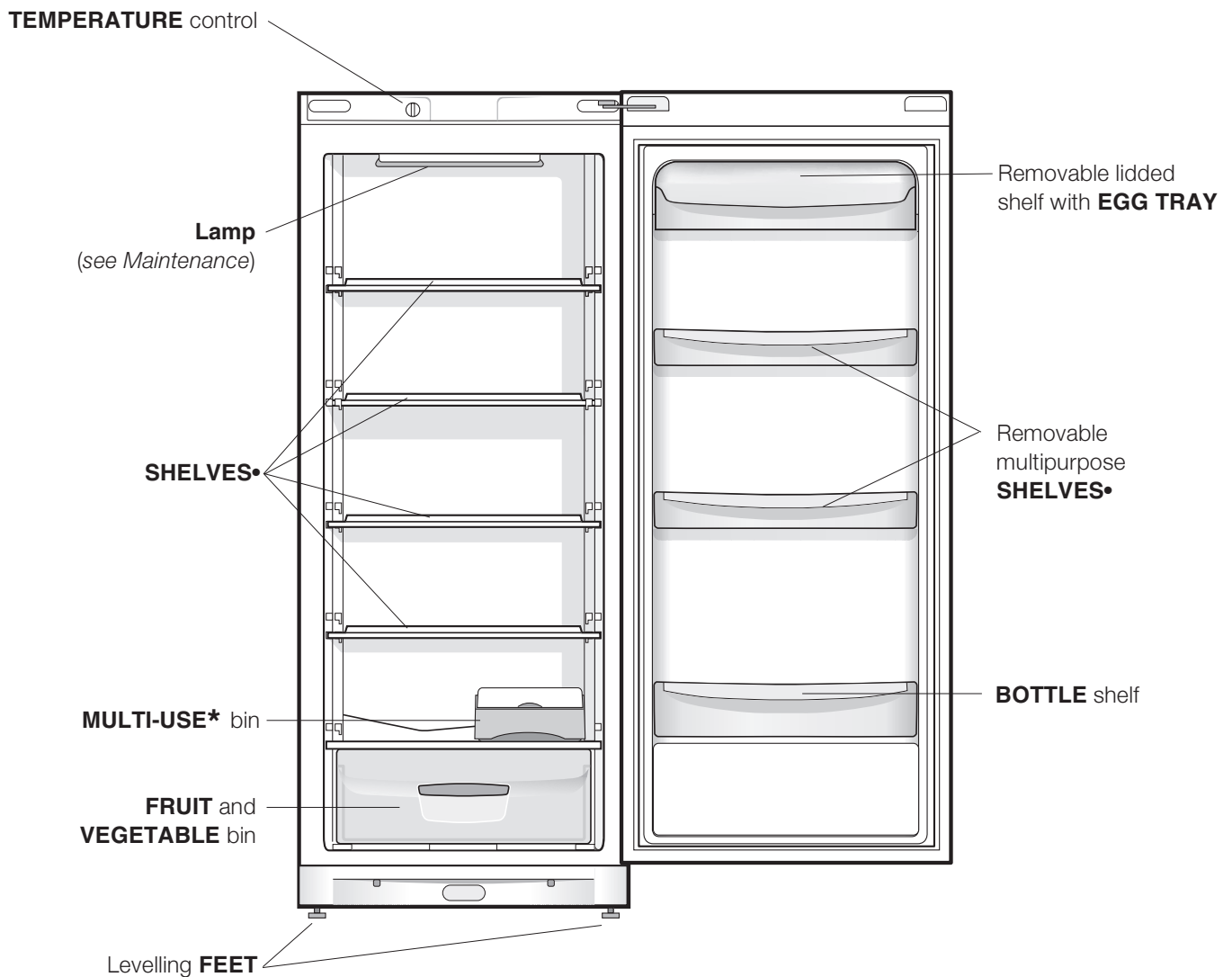

• Varies by number and/or position.

* Available only on certain models.

Accessories

GB

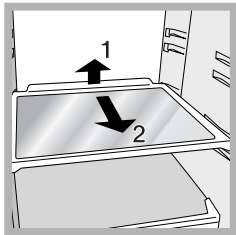

SHELVES: with or without grill. Due to the special guides the shelves are removable and the height is adjustable (see *diagram*), allowing easy storage of large containers and food. Height can be adjusted without complete removal of the shelf.

MULTI-USE* bin: to store food (such as cold meats) for a long time and also prevent odours from lingering in the refrigerator.

TEMPERATURE* Indicator light: to identify the coldest area in the refrigerator.

1. Check that OK appears clearly on the indicator light (see *diagram*).



2. If the word "OK" does not appear it means that the temperature is too high: adjust the REFRIGERATOR OPERATION knob to a higher position (colder) and wait approximately 10 hours until the temperature has been stabilised.
3. Check the indicator light again: if necessary, readjust it following the initial process. If large quantities of food have been added or if the refrigerator door has been opened frequently, it is normal for the indicator not to show OK. Wait at least 10 hours before adjusting the REFRIGERATOR OPERATION knob to a higher setting.

Play Zone*: Thanks to the new "Play Zone" bottle rack, you can cool several bottles, cans and energy drinks quickly to have them constantly at hand.

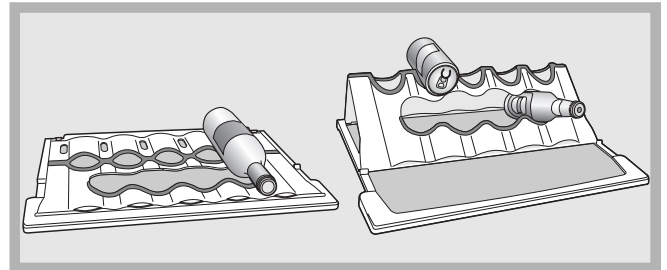

If the "Play Zone" is placed on the glass shelf, you can store large and medium sized bottles on it simply by laying the bottle on the flat rack. This is ideal for storing wine bottles. When folded and secured in place on either side of the shelf, the rack can be used to store cans (at the top), energy drinks (in the centre) and other cans and energy drinks can be rested horizontally on the remaining part of the shelf. When placing cans (onto the Play zone rack), make sure they do not touch the back of the refrigerator interior.

The "Play Zone" can be used just like a normal shelf (when placed flat) and moved up or down along the fridge walls together with the rest of the shelf. It can be washed easily, and is also dishwasher safe. The ideal position for the Play zone rack is the central shelf.

* Available only on certain models.

Start-up and use

Starting the appliance

! Before starting the appliance, follow the installation instructions (see *Installation*).

! Before connecting the appliance, clean the compartments and accessories well with lukewarm water and bicarbonate.

1. Insert the plug into the socket and ensure that the internal light illuminates.
2. Turn the TEMPERATURE ADJUSTMENT knob to an average value. After a few hours you will be able to put food in the refrigerator.

Setting the temperature

The temperature inside the refrigerator compartment automatically adjusts itself according to the position of the thermostat knob.

↑ = warmest

↓ = coldest

We recommend, however, a medium position.

The cooling section of the refrigerator is located inside the back wall of the refrigerator compartment for increased space and improved aesthetics. During operation, the back wall will be covered in frost or water droplets depending on whether the compressor is operating or paused. Do not worry, the refrigerator is functioning normally.

Chiller system

The appliance comes with one of the chiller systems described below: take note of your system in order to determine the most efficient food storage method.

Aircooler

It is recognizable due to the presence of the mechanism on the top part of the refrigerator compartment (see *diagram*).

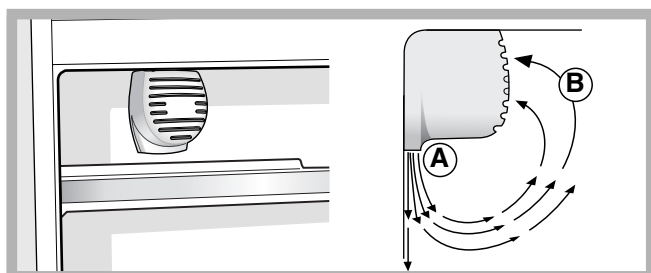

The Aircooler maintains a constant fridge temperature to keep food fresher for longer and will quickly restore the temperature to the correct level, even if the door is opened frequently: the blown air (A) is cooled when it comes into contact with the cold wall, whereas the hotter air (B) is sucked up (see *diagram*).

The back wall may be covered in frost or droplets of water, depending on whether the compressor is in operation or whether it is paused.

Static

Models without the Aircooler have the cooling section in the internal back wall of the compartments. The wall will be covered in frost or water droplets depending on whether the compressor is operating or paused: both cases are normal. If the TEMPERATURE ADJUSTMENT knob has been set on high values with large quantities of food and with a high ambient temperature, the appliance can operate continuously, resulting in excessive frost formation and excessive energy consumption: compensate for this by shifting the knob towards lower values (defrosting will occur automatically).

In static appliances, the air circulates in a natural way: the colder air tends to move downwards as it is heavier. The food should be stored as follows:

Food	Arrangement inside the refrigerator
Fresh fish and meat	Above the fruit and vegetable bins
Fresh cheese	Above the fruit and vegetable bins
Cooked food	On any shelf
Salami, bread loaf, chocolate	On any shelf
Fruit and vegetables	In the fruit and vegetable bins
Eggs	On the shelf provided
Butter and margarine	On the shelf provided
Bottles, drinks, milk	On the shelf provided

Using the refrigerator to its full potential

- Use the TEMPERATURE ADJUSTMENT knob to adjust the temperature (see *Description*).
- Place only cold or lukewarm foods in the compartment, not hot foods (see *Precautions and tips*).
- Remember that cooked foods do not last longer than raw foods.
- Do not store liquids in open containers. They will increase humidity in the refrigerator and cause condensation to form.

Food hygiene

1. Once you have bought your food, remove all external packaging made of paper/cardboard or other wrappers, which could introduce bacteria or dirt inside your refrigerator.
2. Protect the food, (especially easily perishable items and those that have a strong smell), in order to avoid contact between them, thereby removing both the possibility of germ/bacteria contamination as well as the diffusion of strong odours inside the fridge.
3. Store all food in such a way as to ensure air can circulate freely between different items.
4. Keep the inside of your fridge clean, taking care not to use oxidiser or abrasive products.
5. Remove all food past its expiry date from the refrigerator.
6. For the correct preservation of food, all easily perishable items (soft cheeses, raw fish, meat, etc.) should be stored in the coldest zone of the fridge compartment, i.e. just above the salad crisper where the temperature indicator is situated.

Maintenance and care

Switching the appliance off

During cleaning and maintenance it is necessary to disconnect the appliance from the electricity supply: It is not sufficient to set the temperature adjustment knobs on ● (appliance off) to eliminate all electrical contact.

Cleaning the appliance

- The external and internal parts, as well as the rubber seals may be cleaned using a sponge that has been soaked in lukewarm water and bicarbonate of soda or neutral soap. Do not use solvents, abrasive products, bleach or ammonia.
- The removable accessories may be soaked in warm water and soap or dishwashing liquid. Rinse and dry them carefully.
- The back of the appliance may collect dust which can be removed by delicately using the hose of a vacuum cleaner set on medium power. The appliance must be switched off and the plug must be pulled out before cleaning the appliance.

Avoiding mould and unpleasant odours

- The appliance is manufactured with hygienic materials which are odour free. In order to maintain an odour free refrigerator and to prevent the formation of stains, food must always be covered or sealed properly.
- If you want to switch the appliance off for an extended period of time, clean the inside and leave the door open.

Defrosting the appliance

! Follow the instructions below.

Do not speed up the defrosting process by using any tools or electrical devices, you may damage the refrigeration circuit.

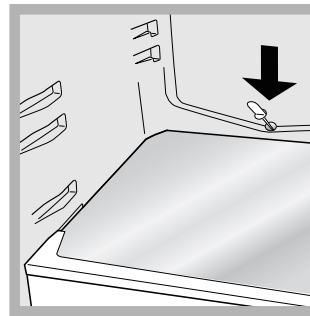

The refrigerator has an automatic defrosting function: water is ducted to the back of the appliance by a special discharge outlet (see *diagram*) where the heat produced by the compressor causes it to evaporate. It is necessary to clean the discharge hole regularly so that the water

can flow out easily.

Replacing the light bulb

To replace the light bulb in the refrigerator compartment, pull out the plug from the electrical socket. Follow the instructions below.

Access the light bulb by removing the cover as indicated in the diagram.

Replace it with a similar light bulb within the power range indicated on the cover (15W or 25W).

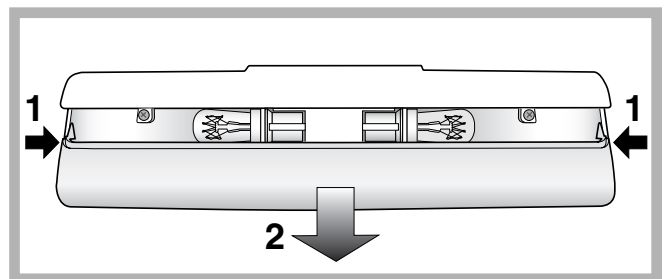

Precautions and tips

GB

! The appliance was designed and manufactured in compliance with international safety standards. The following warnings are provided for safety reasons and must be read carefully.



This appliance complies with the following Community Directives:

- 73/23/EEC of 19/02/73 (Low Voltage) and subsequent amendments;



- 89/336/EEC of 03.05.89 (Electromagnetic Compatibility) and subsequent amendments;
- 2002/96/CE..

General safety

- The appliance was designed for domestic use inside the home and is not intended for commercial or industrial use.
- The appliance must be used to store and freeze food products by adults only and according to the instructions in this manual.
- The appliance must not be installed outdoors, even in covered areas. It is extremely dangerous to leave the appliance exposed to rain and storms.
- Do not touch the appliance with bare feet or with wet or moist hands and feet.
- WARNING: do not damage the refrigerant circuit.
- Do not touch the internal cooling elements: this could cause skin abrasions or frost/freezer burns.
- When unplugging the appliance always pull the plug from the mains socket, do not pull on the cable.
- Before cleaning and maintenance, always switch off the appliance and disconnect it from the electrical supply. It is not sufficient to set the temperature adjustment knobs on ● (appliance off) to eliminate all electrical contact.
- In the case of a malfunction, under no circumstances should you attempt to repair the appliance yourself. Repairs carried out by inexperienced persons may cause injury or further malfunctioning of the appliance.
- Do not use any sharp or pointed utensils or electrical equipment - other than the type recommended by the manufacturer - inside the frozen food storage compartments.
- Do not put ice cubes taken directly from the freezer into your mouth.
- Do not allow children to tamper with the controls or play with the appliance. Under no circumstance should they be allowed to sit on the bins or to hang from the door.
- Keep packaging material out of the reach of children! It can become a choking or suffocation hazard.

Disposal

- Observe local environmental standards when disposing packaging material for recycling purposes.
- The European Directive 2002/96/EC on Waste Electrical and Electronic Equipment (WEEE), requires that old household electrical appliances must not be disposed of in the normal unsorted municipal waste stream. Old appliances must be collected separately in order to optimise the recovery and recycling of the materials they contain and reduce the impact on human health and the environment. The crossed out “wheeled bin” symbol on the product reminds you of your obligation, that when you dispose of the appliance it must be separately collected.

Consumers should contact their local authority or retailer for information concerning the correct disposal of their old appliance.

Respecting and conserving the environment

- Install the appliance in a fresh and well-ventilated room. Ensure that it is protected from direct sunlight and do not place it near heat sources.
- Try to avoid keeping the door open for long periods or opening the door too frequently in order to conserve energy.
- Do not fill the appliance with too much food: cold air must circulate freely for food to be preserved properly. If circulation is impeded, the compressor will work continuously.
- Do not place hot food directly into the refrigerator. The internal temperature will increase and force the compressor to work harder and will consume more energy.
- Defrost the appliance if ice forms (*see Maintenance*). A thick layer of ice makes cold transference to food products more difficult and results in increased energy consumption.
- Regularly check the door seals and wipe clean to ensure they are free of debris and to prevent cold air from escaping (*see Maintenance*).

Troubleshooting

If the appliance does not work, before calling for Assistance (see *Assistance*), check for a solution from the following list.

GB

Malfunctions:

The internal light does not illuminate.

Possible causes / Solutions:

- The plug has not been inserted into the electrical socket, or not far enough to make contact, or there is no power in the house.
- The TEMPERATURE CONTROL Knob is on ● setting.

The refrigerator do not cool well.

- The door do not close properly or the seals are damaged.
- The door are opened too frequently.
- The TEMPERATURE ADJUSTMENT knob is not in the correct position
- The refrigerator have been over-filled.

The food inside the refrigerator is beginning to freeze.

- The TEMPERATURE ADJUSTMENT knob is not in the correct position.
- The food is in contact with the back inside wall of the refrigerator.

The AIR fan does not rotate.

- The refrigerator door is open.
- The AIR system is only activated automatically when it becomes necessary to restore perfect operational conditions inside the refrigerator compartment.

The motor runs continuously.

- The door is not closed properly or is continuously opened.
- The outside ambient temperature is very high.

The appliance makes a lot of noise.

- The appliance has not been installed on a level surface (see *Installation*).
- The appliance has been installed between cabinets that vibrate and make noise.
- The internal refrigerant makes a slight noise even when the compressor is off. This is not a defect, it is normal.

The back wall of the refrigerator unit is covered in frost or droplets of water

- This shows the appliance is operating normally.

There is water at the bottom of the refrigerator.

- The water discharge hole is blocked (see *Maintenance*).

Before calling for Assistance:

- Check if the malfunction can be solved on your own (see *Troubleshooting*).
- If after all the checks, the appliance still does not operate or the problem persists, call the nearest Service Centre

Communicating:

- type of malfunction
- appliance model (Mod.)
- serial number (S/N)

This information can be found on the data plate located on the bottom left side of the refrigerator compartment.

CLASS		REFRIGERANT		VOLUME litres	
V	220-240	TYPE	R600a	TOTAL GROSS	290
Hz	50	g	26	FRIDGE	268
FUSE		FREEZING CAPACITY		CHILLER	0
	80W 0.37A	Kg/24h	0	FREEZER	0
	0V	MADE IN EU			
Ind 76 34529 7600		COMPLIES WITH EN6504:1993 Protected by patents			
		S/N 602060001		Model SAN300	

serial number | model

Never call on unauthorized technicians and always refuse spare parts which are not originals.