

DAILY REFERENCE GUIDE



THANK YOU FOR PURCHASING AN INDESIT PRODUCT

To receive more comprehensive help and support, please register your product at www.indesit.com/register



You can download the Safety Instructions and the Use and Care Guide by visiting our website docs.indesit.eu and following the instructions on the back of this booklet.



Before using the appliance carefully read the Health and Safety guide.

PRODUCT DESCRIPTION

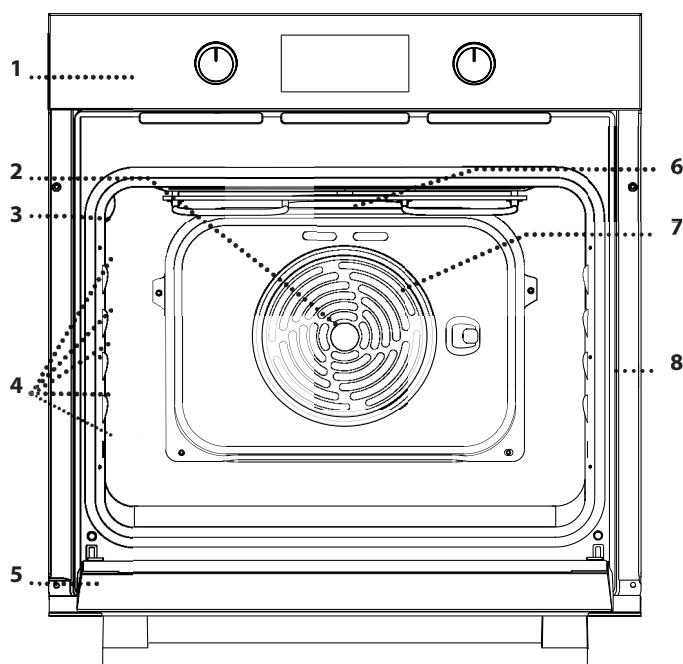

1. Control panel
2. Fan
3. Lamp
4. Shelf runners
(the level is indicated on the wall of the cooking compartment)
5. Door
6. Upper heating element/grill
7. Circular heating element
(non-visible)
8. Identification plate
(do not remove)

CONTROL PANEL

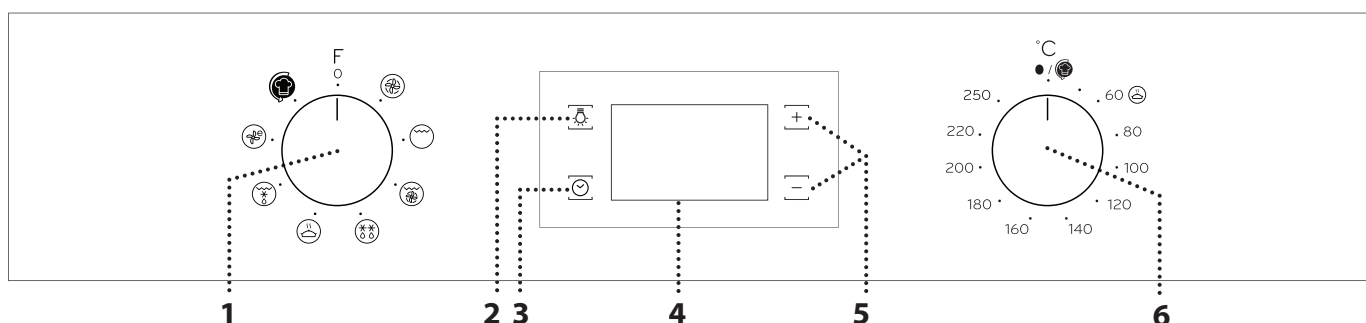

1. SELECTION KNOB

For switching the oven on by selecting a function. Turn to the **O** position to switch the oven off.

2. LIGHT

With the oven switched on, press to turn the oven compartment lamp on or off.

3. SETTING THE TIME

For accessing the cooking time settings, delayed start and timer. For displaying the time when the oven is off.

4. DISPLAY

5. ADJUSTMENT BUTTONS

For changing the cooking time settings.

6. THERMOSTAT KNOB

Turn to select the temperature you require when activating manual functions. For "Turn & Cook" function keep on **●**.

ACCESSORIES



Download the Use and Care Guide from docs.indesit.eu for more information

WIRE SHELF

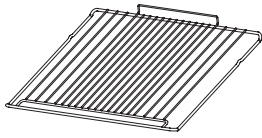

DRIP TRAY (IF PRESENT)

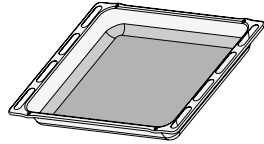

BAKING TRAY

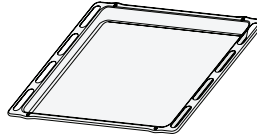

The number and the type of accessories may vary depending on which model is purchased. Other accessories can be purchased separately from the After-sales Service.

USING THE ACCESSORIES

• Insert the wire shelf onto the level you require by holding it tilted slightly upwards and resting the raised rear side (pointing upwards) down first. Then slide it horizontally along the shelf runners as far as possible.

The other accessories, such as the baking tray, are inserted horizontally by sliding them along the shelf runners.

FUNCTIONS



Download the Use and Care Guide from docs.indesit.eu for more information



MULTILEVEL

For cooking different foods that require the same cooking temperature on several shelves (maximum three) at the same time. This function can be used to cook different foods without odours being transferred from one food to another.



GRILL

For grilling steaks, kebabs and sausages, cooking vegetables au gratin or toasting bread. When grilling meat, we recommend using a Baking tray to collect the cooking juices: position the pan on any of the levels below the wire shelf and add 200 ml of drinking water.



GRATIN

For roasting large joints of meat (legs, roast beef, chicken). We recommend using a Baking tray to collect the cooking juices: position the pan on any of the levels below the wire shelf and add 200 ml of drinking water.



DEFROSTING

For defrosting food more quickly.



KEEP WARM

For helping sweet or savoury dough to rise effectively. To maintain the quality of proving, do not activate the function if the oven is still hot following a cooking cycle.



FREASY COOK

All the heating elements and the fan come on, guaranteeing the distribution of heat consistently and uniformly throughout the oven. Pre-heating is not necessary for this cooking mode. This mode is especially recommended for cooking pre-packed food quickly (frozen or pre-cooked). The best results are obtained if you use one cooking rack only.



ECO FORCED AIR

For cooking roasts and stuffed roasting joints on a single shelf. Food is prevented from drying out excessively by gentle, intermittent air circulation. When this ECO function is in use, the light will remain switched off during cooking but can be switched on again by pressing .





TURN & COOK







This function automatically selects an ideal temperature and time for baking a wide range of recipes including meat, fish, pasta, sweets and vegetables. Activate the function when the oven is cold.

USING THE APPLIANCE FOR THE FIRST TIME

1. SETTING THE TIME

You will need to set the time when you switch on the appliance for the first time: Press  until the  icon and the two digits for the hour start flashing on the display.



Use  or  to set the hour and press  to confirm. The two digits for the minutes will start flashing. Use  or  to set the minutes and press  to confirm.

Please note: When the  icon is flashing, for example following lengthy power outages, you will need to reset the time.

2. HEAT THE OVEN

A new oven may release odours that have been left behind during manufacturing: this is completely normal.

Before starting to cook food, we therefore recommend heating the oven with it empty in order to remove any possible odours.

Remove any protective cardboard or transparent film from the oven and remove any accessories from inside it. Heat the oven to 250°C for about one hour, preferably using the "Multilevel" function. The oven must be empty during this time.

Follow the instructions for setting the function correctly.

Please note: It is advisable to air the room after using the appliance for the first time.

DAILY USE

1. SELECT A FUNCTION

To select a function, turn the *selection knob* to the symbol for the function you require: the display will light up and an audible signal will sound.



2. ACTIVATE A FUNCTION

MANUAL

To start the function you have selected, turn the *thermostat knob* to set the temperature you require.

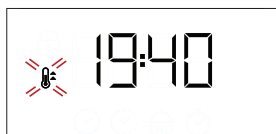

Please note: During cooking you can change the function by turning the *selection knob* or adjust the temperature by turning the *thermostat knob*.

The function will not start if the *thermostat knob* will be on . You can set the cooking time, cooking end time (only if you set a cooking time) and a timer.

TURN & COOK

To start the "Turn & Cook" function, select the function turning the *selection knob* on the relevant icon, keeping the *thermostat knob* on the  position. To end the cooking, turn the *selection knob* on "O".

Please note: You can set the cooking end time and timer. To obtain the best cooking results using the "Turn & Cook" function, follow the suggested weights for each kind of food in the following table.

| Food | Recipe | Weight (kg) |
|-------------|------------------------------------|-------------|
| Meat | Roast veal, Roast Beef rare | 0.6 - 0.7 |
| | Chicken / Leg of lamb in pieces | 1.0 - 1.2 |
| Fish | Salmon fillet / Baked fish (whole) | 0.9 - 1.0 |
| | Fish en papillote | 0.8 - 1.0 |
| Vegetables | Stuffed vegetables | 1.8 - 2.5 |
| | Vegetable pie | 1.5 - 2.5 |
| Salty cakes | Quiche lorraine / Flan | 1.0 - 1.5 |
| Pasta | Lasagne / Timbale of pasta or rice | 1.5 - 2.0 |
| Pastry | Leavened cake / Plum cake | 0.9 - 1.2 |
| | Baked apples | 1.0 - 1.5 |
| Bread | Bread loaf | 0.5 - 0.6 |
| | Baguettes | 0.5 - 0.8 |

KEEP WARM

To start the "Keep Warm" function, turn the *thermostat knob* to the relevant symbol; if the oven is set to a different temperature (or if the cavity temperature is above 65°C) the function will not start.

Please note: You can set the cooking time, cooking end time (only if you set a cooking time) and a timer.

3. PREHEATING

Once the function starts, an audible signal and a flashing icon  on the display indicate that the preheating phase has been activated.



At the end of this phase, an audible signal and the fixed icon  on the display will indicate that the oven has reached the set temperature: at this point, place the food inside and proceed with cooking.

Please note: Placing the food in the oven before preheating has finished may have an adverse effect on the final cooking result.



. PROGRAMMING COOKING

You will need to select a function before you can start programming cooking.



DURATION

Keep pressing  until the  icon and "00:00" start flashing on the display.



Use  or  to set the cooking time you require, then press  to confirm.



Activate the function by turning the *thermostat knob* to the temperature you require: an audible signal will sound and the display will indicate that cooking is complete.

Notes: To cancel the cooking time you have set, keep pressing  until the  icon starts flashing on the display, then use  to reset the cooking time to "00:00". This cooking time includes a preheating phase.

PROGRAMMING THE END COOKING TIME/ DELAYED START

After a cooking time has been set, starting the function can be delayed by programming its end time: press  until the  icon and the current time start flashing on the display.



Use  or  to set the time you want cooking to end and press  to confirm.

Activate the function by turning the *thermostat knob* to the temperature you require: the function will remain paused until it starts automatically after the period of time that has been calculated in order for cooking to finish at the time you have set.

Notes: To cancel the setting, switch the oven off by turning the *selection knob* to the **O** position.

END OF COOKING

An audible signal will sound and the display will indicate that the function has finished.





Turn the *selection knob* to select a different function or to position "O" to switch the oven off.



Please note: If the timer is active, the display will show "END" alternately with the remaining time.

. SETTING THE TIMER

This option does not interrupt or program cooking but allows you to use the display as a timer, either during while a function is active or when the oven is off.

Keep pressing  until the  e "00:00" icon and "00:00" start flashing on the display.















































































Use  or  to set the time you require and press  to confirm.

An audible signal will sound once the timer has finished counting down the selected time.

Notes: To cancel the timer, keep pressing  until the  icon starts flashing, then use  to reset the time to "00:00".

COOKING TABLE

| RECIPE | FUNCTION | PREHEATING | TEMPERATURE (°C) | DURATION (MIN) | LEVEL AND ACCESSORIES |
|---|---|--|---|--|---|
| Leavened cakes |  | Yes | 160 - 180 | 30 - 90 |  |
| |  | Yes | 160 - 180 | 30 - 90 |   |
| Filled cake (cheese cake, strudel, fruit pie) |  | Yes | 160 - 200 | 35 - 90 |  |
| |  | Yes | 160 - 200 | 40 - 90 |   |
| Biscuits/tartlets |  | Yes | 150 - 170 | 15 - 35 |  |
| |  | Yes | 150 - 170 | 20 - 45 |   |
| |  | Yes | 150 - 170 | 20 - 45 |    |
| Choux buns |  | Yes | 180 - 200 | 30 - 50 |  |
| |  | Yes | 180 - 200 | 35 - 45 |   |
| |  | Yes | 180 - 200 | 35 - 45 |    |
| Meringues |  | Yes | 90 | 150 - 200 |  |
| |  | Yes | 90 | 140 - 200 |   |
| |  | Yes | 90 | 140 - 200 |    |
| Pizza / Focaccia |  | Yes | 220 - 250 | 10 - 25 |  |
| |  | Yes | 200 - 240 | 20 - 45 |   |
| Small bread 80g |  | Yes | 180 - 200 | 30 - 45 |  |
| Bread |  | Yes | 180 - 200 | 30 - 80 |   |
| Frozen pizzas |  | No | 220 - 250 | 15 - 25 |  |
| Salty cakes (vegetable pie, quiche) |  | Yes | 180 - 200 | 30 - 45 |  |
| |  | Yes | 180 - 200 | 45 - 60 |   |
| |  | Yes | 180 - 200 | 45 - 60 |    |
| Vols-au-vents / puff pastry crackers |  | Yes | 180 - 190 | 20 - 30 |  |
| |  | Yes | 180 - 190 | 20 - 40 |   |
| |  | Yes | 190 - 200 | 20 - 40 |    |
| FUNCTIONS |  Grill |  Gratin |  Forced air |  Frozy Cook | |
| ACCESSORIES |  Wire shelf |  Baking dish or cake tin on the wire shelf |  Baking tray/Drip tray or Baking dish on the wire shelf |  Drip tray / Baking tray |  Drip tray / Baking tray with 200 ml of water |

| RECIPE | FUNCTION | PREHEATING | TEMPERATURE (°C) | DURATION (MIN) | LEVEL AND ACCESSORIES |
|---|----------|------------|------------------|----------------|-----------------------|
| Frozen lasagna | | No | 200 - 220 | 30 - 50 | 3 |
| Lasagne / baked pasta / cannelloni / flans | | Yes | 200 - 220 | 45 - 65 | 3 |
| Lamb / veal / beef /pork 1 kg | | Yes | 180 - 200 | 80 - 110 | 3 |
| Chicken/rabbit/duck 1 kg | | Yes | 180 - 200 | 50 - 100 | 3 |
| Turkey / goose 3 kg | | Yes | 200 - 230 | 150 - 200 | 2 |
| Baked fish / en papillote 0.5 kg (fillets, whole) | | Yes | 180 - 200 | 30 - 45 | 3 |
| Stuffed vegetables (tomatoes, courgettes, aubergines) | | Yes | 170 - 190 | 50 - 70 | 2 |
| Roast potatoes | | Yes | 180 - 200 | 30 - 50 | 3 |
| Toasted bread | | 5' | 200 - 220 | 2 - 6 | 5 |
| Fish fillets / slices | | - | 250 | 15 - 30 | 4 3 |
| Sausages / kebabs / spare ribs / hamburgers | | - | 230 - 250 | 15 - 30 | 5 4 |
| Roast chicken 1-1.3 kg | | Yes | 250 | 55 - 70 | 2 1 |
| Roast beef rare 1 kg | | Yes | 200 - 220 | 35 - 50 | 3 |
| Leg of lamb / knuckle | | Yes | 200 - 210 | 60 - 90 | 3 |
| Roast potatoes | | Yes | 200 - 210 | 35 - 55 | 3 |
| Vegetable gratin | | - | 200 - 210 | 25 - 55 | 3 |
| Meat and potatoes | | Yes | 190 - 200 | 45 - 100 | 4 1 |
| Fish and vegetables | | Yes | 180 | 30 - 50 | 4 2 |
| Lasagne and meat | | Yes | 200 | 50 - 100 | 4 1 |
| Complete meal: fruit tart (level 5) / lasagne (level 3) / meat (level 1) | | Yes | 180 - 190 | 40 - 120 | 5 3 1 |

The time indicated does not include the preheating phase: we recommend placing the food in the oven and setting the cooking time only after the required temperature has been reached.

* Turn food halfway through cooking.

** Turn food two thirds of the way through cooking (if necessary).

*** Estimated length of time: dishes can be removed from the oven at different times depending on personal preference.

Download the Use and Care Guide from docs.indesit.eu for the table of tested recipes, compiled for the certification authorities in accordance with the standard IEC 60350-1.

| | | | | |
|-------------|------------|---|--|--|
| FUNCTIONS | | | | |
| | Grill | Gratin | Forced air | Frozy Cook |
| ACCESSORIES | | | | |
| | Wire shelf | Baking dish or cake tin on the wire shelf | Baking tray/Drip tray or Baking dish on the wire shelf | Drip tray / Baking tray with 200 ml of water |

MAINTENANCE AND CLEANING



Download the Use and Care Guide from
docs.indesit.eu for more information

Do not use steam cleaning equipment.

Use protective gloves during all operations.

Carry out the required operations with the oven cold.

Disconnect the appliance from the power supply.

Do not use wire wool, abrasive scourers or abrasive/corrosive cleaning agents, as these could damage the surfaces of the appliance.

EXTERIOR SURFACES

Clean the surfaces with a damp microfibre cloth. If they are very dirty, add a few drops of pH-neutral detergent. Finish off with a dry cloth. Do not use corrosive or abrasive detergents. If any of these products inadvertently comes into contact with the surfaces of the appliance, clean immediately with a damp microfibre cloth.

INTERIOR SURFACES

• After every use, leave the oven to cool and then clean it, preferably while it is still warm, to remove any deposits or stains caused by food residues. To dry any condensation that has formed as a result of cooking foods with a high water content, leave the oven to cool completely and then wipe it with a cloth or sponge.

- The door can be easily removed and refitted to facilitate cleaning of the glass
- Clean the glass in the door with a suitable liquid detergent.
- The top heating element of the grill can be lowered to clean the upper panel of the oven: Extract the heating element from its seating, then lower it. To return the heating element to its position, lift it up, pull it slightly towards you and make sure that the tab support is in its proper seating.

ACCESSORIES

Soak the accessories in a washing-up liquid solution after use, handling them with oven gloves if they are still hot. Food residues can be removed using a washing-up brush or a sponge.

REMOVING AND REFITTING THE DOOR

1. To remove the door, open it fully and lower the catches until they are in the unlock position.

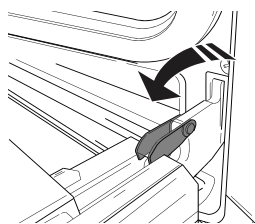

2. Close the door as much as you can. Take a firm hold of the door with both hands – do not hold it by the handle. Simply remove the door by continuing to close it while pulling it upwards (a) at the same time until it is released from its seating (b).

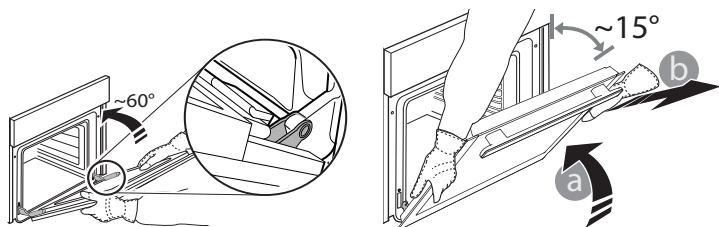

Put the door to one side, resting it on a soft surface.

3. Refit the door by moving it towards the oven, aligning the hooks of the hinges with their seating and securing the upper part onto its seating.

4. Lower the door and then open it fully. Lower the catches into their original position: make sure that you lower them down completely.

5. Try closing the door and check to make sure that it lines up with the control panel. If it does not, repeat the steps above.

CLICK TO CLEAN - CLEANING THE GLASS

1. After removing the door and resting it on a soft surface with the handle downwards, simultaneously press the two retaining clips and remove the upper edge of the door by pulling it towards you.

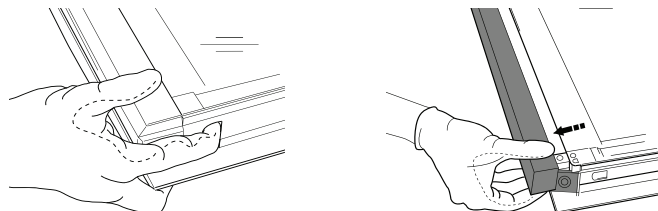

2. Lift and firmly hold the inner glass with both hands, remove it and place it on a soft surface before cleaning it.

3. To correctly reposition the inner glass, make sure that the "R" is visible in the left-hand corner and the clear surface (not printed) is facing up. First insert the long side of the glass indicated by "R" into the support seats, then lower it into position.

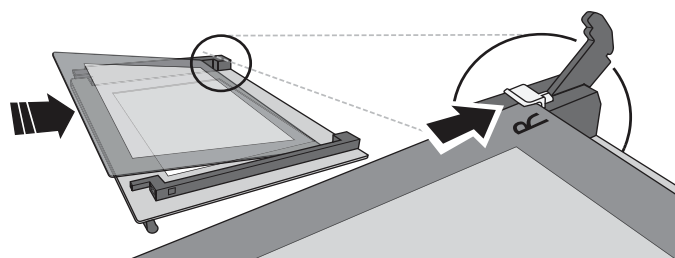

4. Refit the upper edge: a click will indicate correct positioning. Make sure the seal is secure before refitting the door.

| Problem | Possible cause | Solution |
|--|---|---|
| The oven does not work. | Power cut. Disconnection from the mains. | Check for the presence of mains electrical power and whether the oven is connected to the electricity supply. Turn off the oven and restart it to see if the fault persists. |
| The display shows the letter "F" followed by a number. | Software problem. | Contact your nearest After-sales Service Centre and state the letter or number that follows the letter "F". |

USEFUL TIPS



Download the Use and Care Guide from docs.indesit.eu for more information

HOW TO READ THE COOKING TABLE

The table lists the best function, accessories and level to use to cook various different types of food. Cooking times start from the moment food is placed in the oven, excluding preheating (where required). Cooking temperatures and times are approximate and depend on the amount of food and the type of accessory used. Use the lowest recommended settings to begin with and, if the food is not cooked enough, then switch to higher settings. Use the accessories supplied and preferably dark-coloured metal cake tins and baking trays. You can also use Pyrex or stoneware pans and accessories, but bear in mind that cooking times will be slightly longer.

COOKING DIFFERENT FOODS AT THE SAME TIME

The "Multilevel" function enables you to cook different foods (such as fish and vegetables) on different shelves at the same time. Remove the food which requires a shorter cooking time and leave the food which requires a longer cooking time in the oven.

PRODUCT FICHE

The product fiche with energy data of this appliance can be downloaded from the website docs.indesit.eu

HOW TO OBTAIN THE USE AND CARE GUIDE

> Download the Use and Care Guide from our website docs.indesit.eu (you can use this QR Code), specifying the product's commercial code.



> Alternatively, contact our Client After-sales Service.

CONTACTING OUR AFTER-SALES SERVICE

You can find our contact details in the warranty manual. When contacting our Client After-sales Service, please state the codes provided on your product's identification plate.

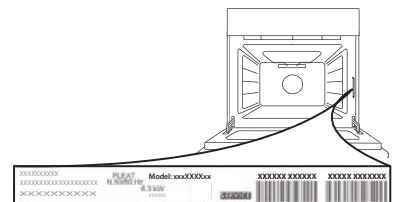

400010897283

Printed in Italy

