

Amica

507EE1.30HPFG(W)

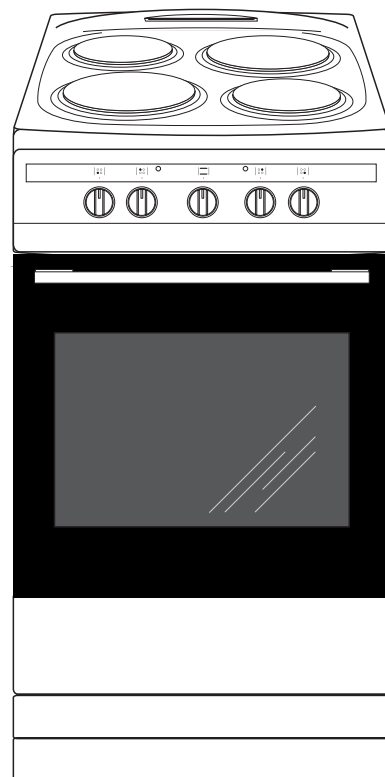

INSTRUCTION MANUAL

ELECTRIC COOKER

IOAK-2420/ 8054080
(01.2014./1)

DEAR CUSTOMER,

The cooker is exceptionally easy to use and extremely efficient. After reading the instruction manual, operating the cooker will be easy.

Before being packaged and leaving the manufacturer, the cooker was thoroughly checked with regard to safety and functionality.

*Before using the appliance, please read the instruction manual carefully.
By following these instructions carefully you will be able to avoid any problems in using the appliance.*

It is important to keep the instruction manual and store it in a safe place so that it can be consulted at any time.

It is necessary to follow the instructions in the manual carefully in order to avoid possible accidents.

Caution!

Do not use the cooker until you have read this instruction manual.

The cooker is intended for household use only.

The manufacturer reserves the right to introduce changes which do not affect the operation of the appliance.

TABLE OF CONTENTS

Safety instructions	4
Description of the appliance	9
Installation	11
Operation	13
Baking in the oven – practical hints	17
Cleaning and maintenance	19
Technical data	24

SAFETY INSTRUCTIONS

Warning: The appliance and its accessible parts become hot during use. Care should be taken to avoid touching heating elements. Children less than 8 years of age shall be kept away unless continuously supervised.

This appliance can be used by children aged from 8 years and above and persons with reduced physical, sensory or mental capabilities or lack of experience and knowledge if they have been given supervision or instruction concerning use of the appliance in a safe way and understand the hazards involved. Children shall not play with the appliance. Cleaning and user maintenance shall not be made by children without supervision.

Warning: Unattended cooking on a hob with fat or oil can be dangerous and may result in fire.

NEVER try to extinguish a fire with water, but switch off the appliance and then cover flame e.g. with a lid or a fire blanket.

Warning: Danger of fire: do not store items on the cooking surfaces.

SAFETY INSTRUCTIONS

During use the appliance becomes hot. Care should be taken to avoid touching heating elements inside the oven.

Accessible parts may become hot during use. Young children should be kept away.

Warning: Do not use harsh abrasive cleaners or sharp metal scrapers to clean the oven door glass since they can scratch the surface, which may result in shattering of the glass.

Warning: Ensure that the appliance is switched off before replacing the lamp to avoid the possibility of electric shock.

Before opening the cover, cleaning it of any dirt is recommended. The cooker hob surface should be cooled down before closing the cover.

You should not use steam cleaning devices to clean the appliance.

SAFETY INSTRUCTIONS

- The appliance becomes hot during operation. Take care not to touch the hot parts inside the oven.
- Always keep children away from the cooker.
While in operation direct contact with the cooker may cause burns!
- Ensure that small items of household equipment, including connection leads, do not touch the hot oven or the hob as the insulation material of this equipment is usually not resistant to high temperatures.
- Do not leave the cooker unattended when frying. Oils and fats may catch fire due to overheating or boiling over.
- Do not put pans weighing over 15 kg on the opened door of the oven and pans over 25 kg on the hob.
- Do not use harsh cleaning agents or sharp metal objects to clean the door as they can scratch the surface, which could then result in the glass cracking.
- Do not use the cooker in the event of a technical fault. Any faults must be fixed by an appropriately qualified and authorised person.
- In the event of any incident caused by a technical fault, disconnect the power and report the fault to the service centre to be repaired.
- The rules and provisions contained in this instruction manual should be strictly observed. Do not allow anybody who is not familiar with the contents of this instruction manual to operate the cooker.
- The appliance has been designed only for cooking. Any other use (for example for heating) does not comply with its operating profile and may cause danger.

HOW TO SAVE ENERGY



Using energy in a responsible way not only saves money but also helps the environment. So let's save energy! And this is how you can do it:

- **Use proper pans for cooking.**

Pans with thick, flat bases can save up to 1/3 on electric energy. Remember to cover pans if possible otherwise you will use four times as much energy!

- **Match the size of the saucepan to the surface of the heating plate.**

A saucepan should never be smaller than a heating plate.

- **Ensure heating plates and pan bases are clean.**

Soils can prevent heat transfer – and repeatedly burnt-on spillages can often only be removed by products which cause damage to the environment.

- **Do not uncover the pan too often (a watched pot never boils!).**

Do not open the oven door unnecessarily often.

- **Switch off the oven in good time and make use of residual heat.**

For long cooking times, switch off heating plates 5 to 10 minutes before finishing cooking. This saves up to 20% on energy.

- **Only use the oven when cooking larger dishes.**

Meat of up to 1 kg can be prepared more economically in a pan on the cooker hob.

- **Make use of residual heat from the oven.**

If the cooking time is greater than 40 minutes switch off the oven 10 minutes before the end time.

Important! When using the timer, set appropriately shorter cooking times according to the dish being prepared.

- **Make sure the oven door is properly closed.**

Heat can leak through spillages on the door seals. Clean up any spillages immediately.

- **Do not install the cooker in the direct vicinity of refrigerators/freezers.**

Otherwise energy consumption increases unnecessarily.

UNPACKING

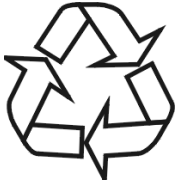

During transportation, protective packaging was used to protect the appliance against any damage. After unpacking, please dispose of all elements of packaging in a way that will not cause damage to the environment.

All materials used for packaging the appliance are environmentally friendly; they are 100% recyclable and are marked with the appropriate symbol.

Caution! During unpacking, the packaging materials (polythene bags, polystyrene pieces, etc.) should be kept out of reach of children.

DISPOSAL OF THE APPLIANCE



Old appliances should not simply be disposed of with normal household waste, but should be delivered to a collection and recycling centre for electric and electronic equipment. A symbol shown on the product, the instruction manual or the packaging shows that it is suitable for recycling.

Materials used inside the appliance are recyclable and are labelled with information concerning this. By recycling materials or other parts from used devices you are making a significant contribution to the protection of our environment.

Information on appropriate disposal centres for used devices can be provided by your local authority.

DESCRIPTION OF THE APPLIANCE

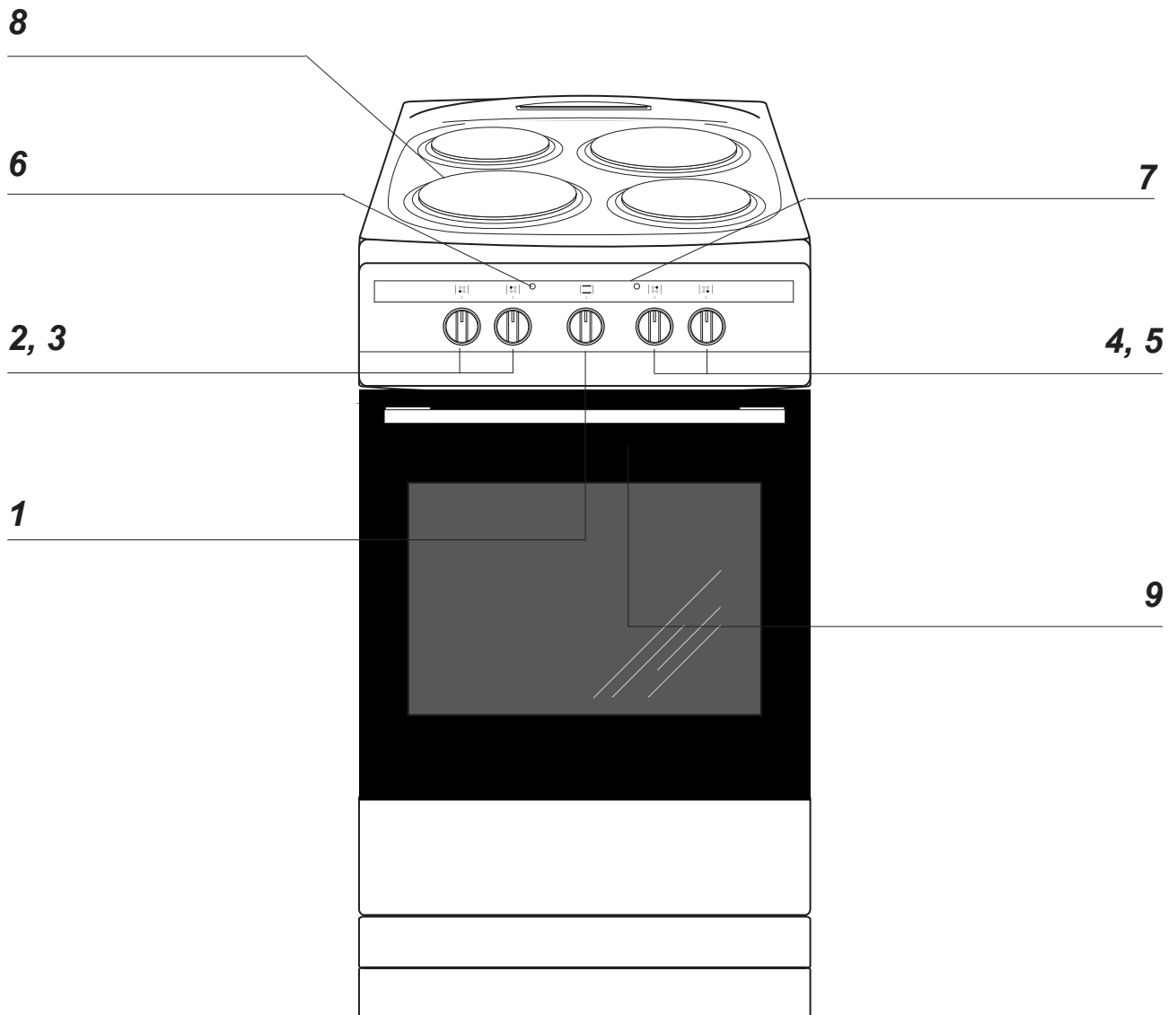

- 1** Temperature control knob / Oven function selection knob
- 2, 3, 4, 5** Heating plate control knobs
- 6** Temperatureregulatorsignal light **L**
- 7** Cooker operation signal light yellow **R**
- 8** Electric hob
- 9** Oven door handle

SPECIFICATIONS OF THE APPLIANCE

Oven fittings:

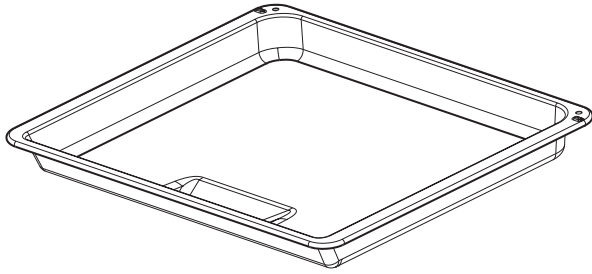

Roasting tray

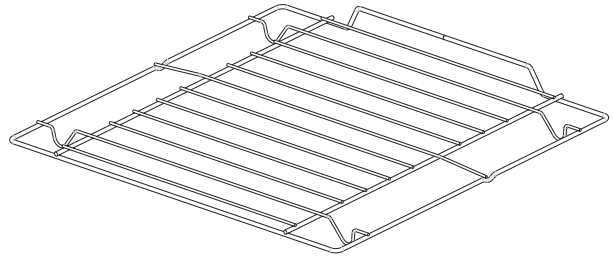

*Grill grate
(drying rack)*

INSTALLATION

Installing the cooker

- The kitchen should be dry and airy and have effective ventilation according to the existing technical provisions.
- The room should be equipped with a ventilation system that pipes away exhaust fumes created during combustion. This system should consist of a ventilation grid or hood. Hoods should be installed according to the manufacturer's instructions. The cooker should be placed so as to ensure free access to all control elements.
- Coating or veneer used on fitted furniture must be applied with a heat resistant adhesive (100°C). This prevents surface deformation or detachment of the coating. If you are unsure of your furniture's heat resistance, you should leave approximately 2 cm of free space around the cooker. The wall behind the cooker should be resistant to high temperatures. During operation, its back side can warm up to around 50°C above the ambient temperature.
- The cooker should stand on a hard, even floor (do not put it on a base).
- Before you start using the cooker it should be leveled, which is particularly important for fat distribution in a frying pan. To this purpose, adjustable feet are accessible after removal of the drawer. The adjustment range is +/- 5 mm.

Mounting the overturning prevention bracket.

The bracket is mounted to prevent overturning of the cooker. When the overturning prevention bracket is installed, a child who climbs on the oven door will not overturn the appliance.

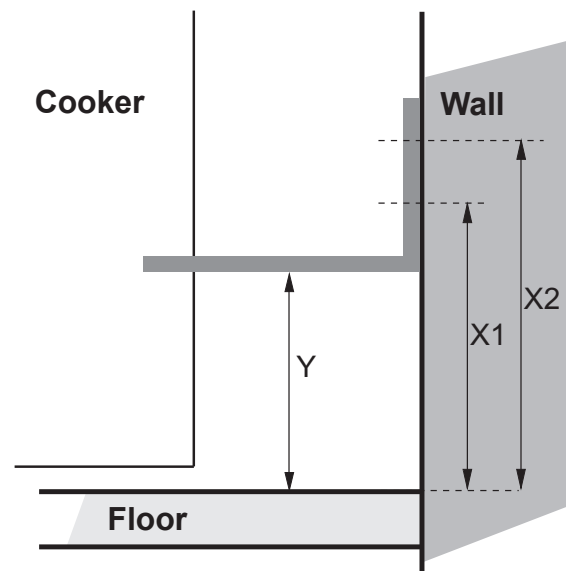

Cooker width W 500 mm, height 850 mm
 $X1=Y+30$ mm
 $X2=Y+65$ mm
 $Y=25$ mm

Cooker width W 500 mm, height 900 mm
 $X1=Y+30$ mm
 $X2=Y+65$ mm
 $Y=70$ mm

X - distance to wall mounting
Y - distance from the floor

INSTALLATION

Electrical connection

Warning: This appliance must be earthed.

The appliance must be installed by a competent electrician using a double pole control unit of 32 ampere minimum capacity with 3mm minimum contact separation at all poles.

We recommend that the appliance is connected by a qualified electrician who is member of the N.C.E.I.C. and who will comply with the I.E.E. and local regulation.

- Access to the main terminal is gained by opening the terminal block cover at the rear of the appliance (use a small flat-bladed screwdriver).
- Connection should be made with 6mm² twin and earth cable.
- First strip the wires, then push the cable through the cable clamp in the terminal block cover.
- Connect the cable to the terminal block and tighten the cable clamp screw (see diagram).
- Close the terminal box, ensuring that the cover is engaged on the locking tabs.

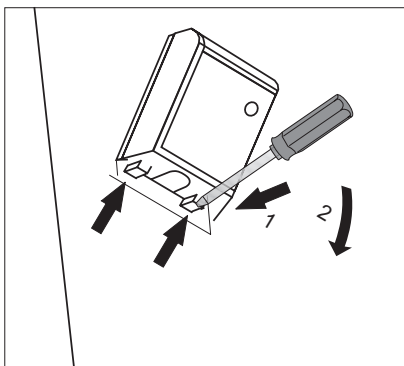
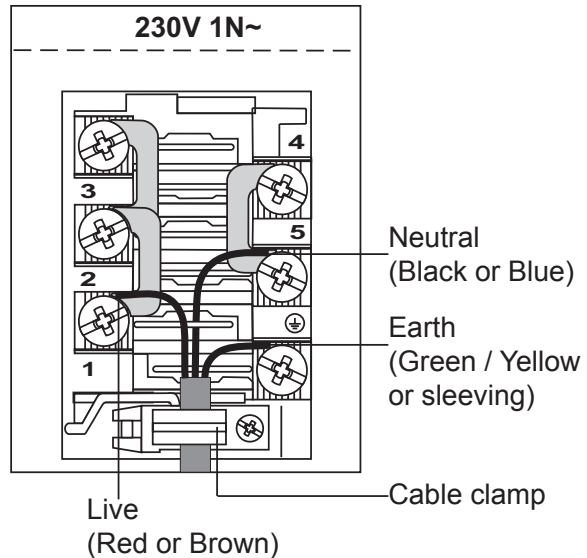

OPERATION

Before first use

- Remove packaging, clean the interior of the oven and the hob.
- Take out and wash the oven fittings with warm water and a little washing-up liquid.
- Switch on the ventilation in the room or open a window.
- Heat the oven (to a temperature of 250°C, for approx. 30 min.), remove any stains and wash carefully; the heating plates of the hob should be heated for around 4 min. without a pan.

OPERATION

► How to use the heating plate

The level of heat can be adjusted gradually by turning the appropriate knob to the right or left. Switching on the plate results in a yellow signal light on the control panel turning on.

An appropriately selected pan saves energy. A pan should have a thick, flat base with a diameter equal to the plate diameter, as in that case heat is transferred most efficiently.

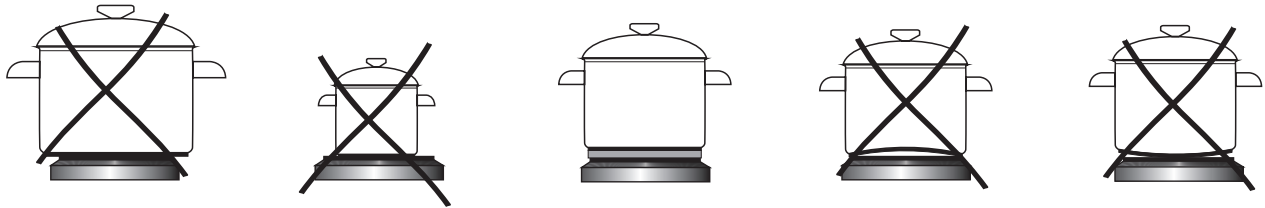

- 0 Switch off
- MIN. Warming up
- 1 Stewing vegetables, slow cooking
- Cooking soups, larger dishes
- 2 Slow frying
- Grilling meat, fish
- 3 MAX. Fast heating up, fast cooking, frying

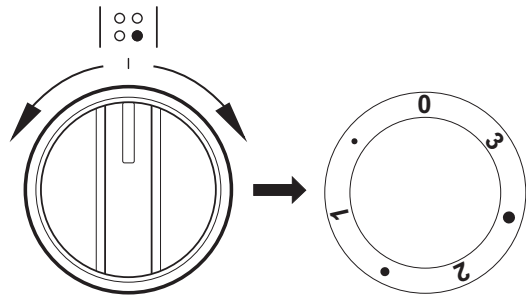

Do not switch on heating plate until the pan has been placed on it.

Caution!

Ensure the plate is clean – a soiled zone does not transfer all of the heat.

Protect the plate against corrosion.
Switch off the plate before a pan is removed.

Do not leave pans with prepared dishes based on fats and oils unattended on the switched – on plate; hot fat can spontaneously catch fire.

OPERATION

Oven functions and operation.

Natural convection oven (conventional)

The oven can be heated up using the bottom and top heaters, and the grill (if any). The oven is controlled by one knob handling, serving as a work type switch integrated with a temperature regulator.

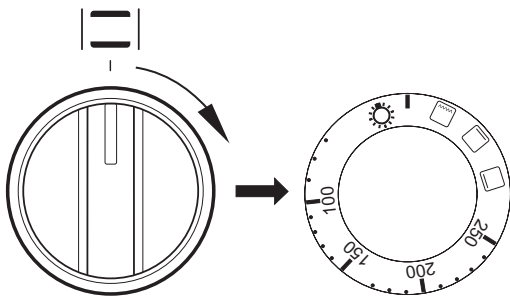

Possible knob positions



Separate oven lighting

By setting the knob to this position, the lighting inside the oven is switched on. Use, for example, when washing the oven chamber.



50-250
°C

Bottom and top heaters on

The thermostat enables the user to set the temperature within a range from 50°C to 250°C. Use for baking.



Bottom heater on

When the knob is set to this position, the oven is heated using only the bottom heater. Use for, e.g. final baking from the bottom.



Top heater on

When the knob is set to this position, the oven is heated using only the top heater, e.g. use for, final baking from above.



Grill heater on

Setting the knob to this position allows dishes to be grilled on the grate.

Oven on and off

In order to switch on the oven you need to:

- set required working conditions of the oven, its temperature and a mode of heating,
- set the knob to the required position, turning it right.

Switching on the oven is indicated by two signal lights, yellow and red, turning on. The yellow light turned on means the oven is working. If the red light goes out, it means the oven has reached the set temperature. If a recipe recommends placing dishes in a warmed-up oven, this should be not done before the red light goes out for the first time. When baking, the red light will temporarily come on and go out (to maintain the temperature inside the oven). The yellow signal light may also turn on at the knob position of “oven chamber lighting”.

Switching off the oven – in order to switch off the oven, set the knob to the “0” knob position, turning it left. The signal light should go out.

OPERATION

Use of the grill

The grilling process operates through infrared rays emitted onto the dish by the incandescent grill heater.

In order to switch on the grill you need to:

- Set the oven knob to the position marked grill ,
- Heat the oven for approx. 5 minutes (with the oven door shut).
- Insert a tray with a dish onto the appropriate cooking level; and if you are grilling on the grate insert a tray for dripping on the level immediately below (under the grate).
- Close the oven door.

Warning!

When using function grill it is recommended that the oven door is closed.

When the grill is in use accessible parts can become hot.

It is best to keep children away from the oven.

BAKING IN THE OVEN – PRACTICAL HINTS

Baking





















- we recommend using the baking trays which were provided with your cooker;
- it is also possible to bake in cake tins and trays bought elsewhere which should be put on the drying rack; for baking it is better to use black trays which conduct heat better and shorten the baking time;
- shapes and trays with bright or shiny surfaces are not recommended when using the conventional heating method (top and bottom heaters), use of such tins can result in undercooking the base of cakes;
- before the cake is taken out of the oven, check if it is ready using a wooden stick (if the cake is ready the stick should come out dry and clean after being inserted into the cake);
- after switching off the oven it is advisable to leave the cake inside for about 5 min.;
- the baking parameters given in Table are approximate and can be corrected based on your own experience and cooking preferences;
- if information given in recipe books is significantly different from the values included in this instruction manual, please apply the instructions from the manual.

Roasting meat

- cook meat weighing over 1 kg in the oven, but smaller pieces should be cooked on the gas burners.
- use heatproof ovenware for roasting, with handles that are also resistant to high temperatures;
- when roasting on the drying rack or the grate we recommend that you place a baking tray with a small amount of water on the lowest level of the oven;
- it is advisable to turn the meat over at least once during the roasting time and during roasting you should also baste the meat with its juices or with hot salty water – do not pour cold water over the meat.

BAKING IN THE OVEN – PRACTICAL HINTS

Natural convection oven (conventional)

Type of dish	Oven functions 	Temperature °C	Level (4)	Time in minutes 
		160 - 200	2 - 3	30 - 50
		160 - 180	2	20 - 40*
		220 - 240	3	10 - 15
		210 - 220	2	45 - 60
		210	4	14 - 18
		225 - 250	2	120 - 150
		160 - 230	2	90 - 120
		160 - 180	2	45 - 60
		190 - 210	2	40 - 50

* Baking smaller items

Caution!

The figures given in Tables are approximate and can be adapted based on your own experience and cooking preferences.

CLEANING AND MAINTENANCE

By ensuring proper cleaning and maintenance of your cooker you can have a significant influence on the continuing fault-free operation of your appliance.

Before you start cleaning, the cooker must be switched off and you should ensure that all knobs are set to the “●”/“0” position. Do not start cleaning until the cooker has completely cooled.

Electric hob

From time to time a lukewarm heating plate should be covered with a thin layer of an available lubricating agent,. It is recommended to use engine oil applied for sewing machines or bicycles. Do not apply edible oil, because its salt contents may damage the plates. Dried up spillage on the surface or rim of the plates should be removed with a dry pad or brush.

Do not use abrasives, because they may cause the forming of rust on the plates. By no means rub the plates with abrasive paper.

Take care not to let salt drop on the plates. It dissolves in water producing ugly rust spots. Use only dry pots and do not put wet lids on the plates. The enamel parts of the cooker can be wiped with a gentle rinsing solution and dried with a soft cloth. Spillage can be wiped during cooking with a dry cloth, to prevent building up of hard to clean burnt deposits.

Chrome plated parts (e.g. rings around heating plates can be easily polished with a soft cloth).

CLEANING AND MAINTENANCE

Oven

- The oven should be cleaned after every use. When cleaning the oven the lighting should be switched on to enable you to see the surfaces better.
- The oven chamber should only be washed with warm water and a small amount of washing-up liquid.

Caution!

Do not use cleaning products containing abrasive materials for the cleaning and maintenance of the glass front panel.

Replacement of the oven light bulb

In order to avoid the possibility of an electric shock ensure that the appliance is switched off before replacing the bulb.

- Set all control knobs to the position “●”/“0” and disconnect the mains plug,
- unscrew and wash the lamp cover and then wipe it dry.
- unscrew the light bulb from the socket, replace the bulb with a new one – a high temperature bulb (300°C) with the following parameters:
 - voltage 230 V
 - power 25 W
 - thread E14.

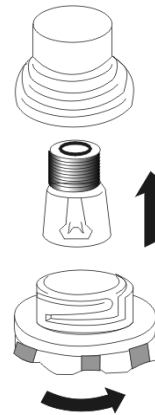

Oven light bulb

- Screw the bulb in, making sure it is properly inserted into the ceramic socket.
- Screw in the lamp cover.

CLEANING AND MAINTENANCE

Door removal

In order to obtain easier access to the oven chamber for cleaning, it is possible to remove the door. To do this, tilt the safety catch part of the hinge upwards (fig. A). Close the door lightly, lift and pull it out towards you. In order to fit the door back on to the cooker, do the inverse. When fitting, ensure that the notch of the hinge is correctly placed on the protrusion of the hinge holder. After the door is fitted to the oven, the safety catch should be carefully lowered down again. If the safety catch is not set it may cause damage to the hinge when closing the door.

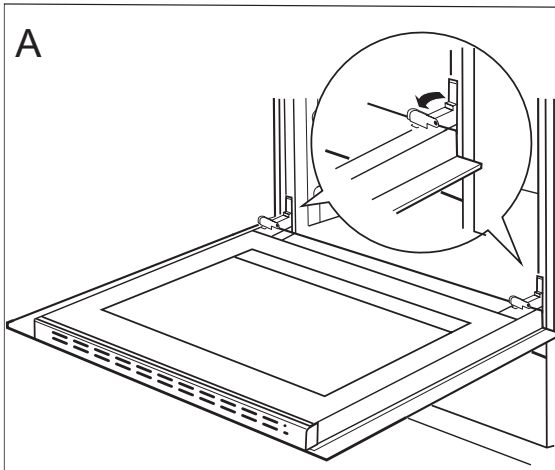

Tilting the hinge safety catches

Removing the inner panel

1. Using a flat screwdriver unhook the upper door slat, prying it gently on the sides (fig. B).
2. Pull the upper door slat loose. (fig. B, C)

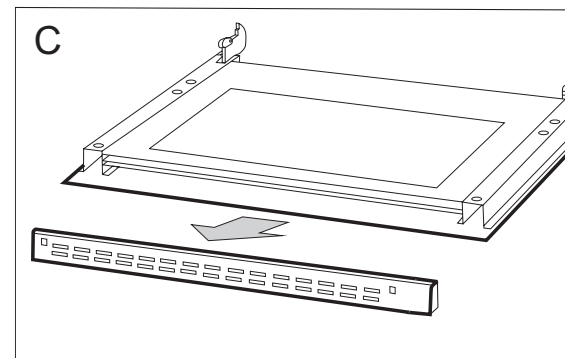
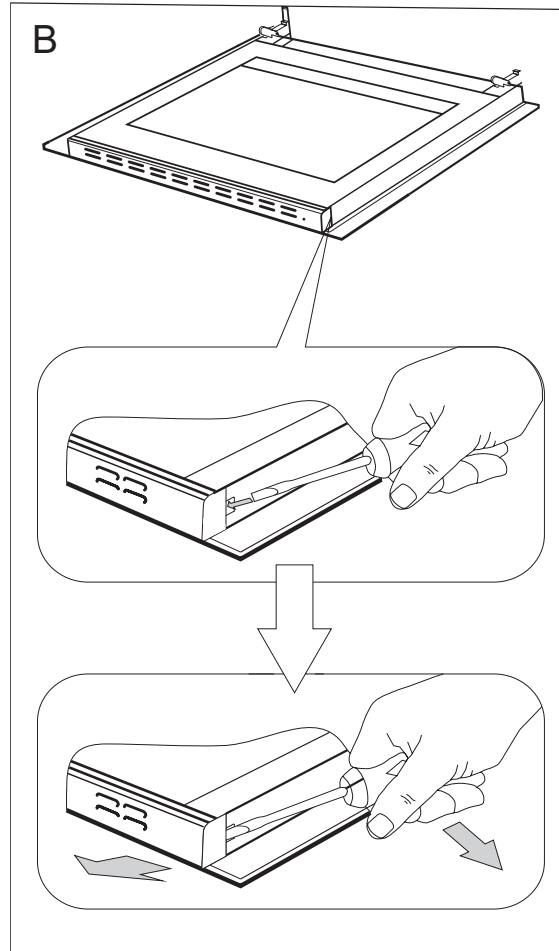

CLEANING AND MAINTENANCE

3. Pull the inner glass panel from its seat (in the lower section of the door). Remove the inner panel (fig. D, D1).

4. Clean the panel with warm water with some cleaning agent added.

Carry out the same in reverse order to reassemble the inner glass panel. Its smooth surface shall be pointed upwards.

Important! Do not force the upper strip in on both sides of the door at the same time. In order to correctly fit the top door strip, first put the left end of the strip on the door and then press the right end in until you hear a "click". Then press the left end in until you hear a "click".

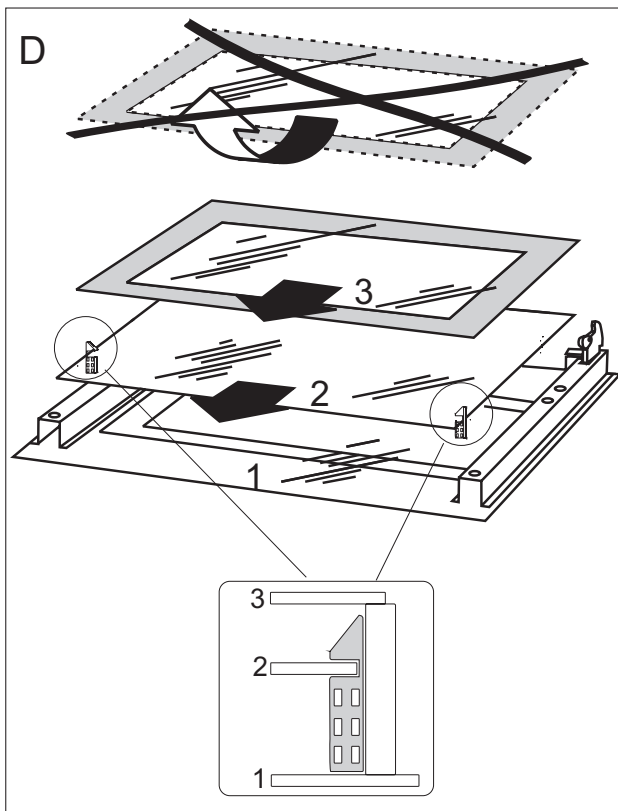

*Removal of the internal glass panel.
3 glass panel.*

D1

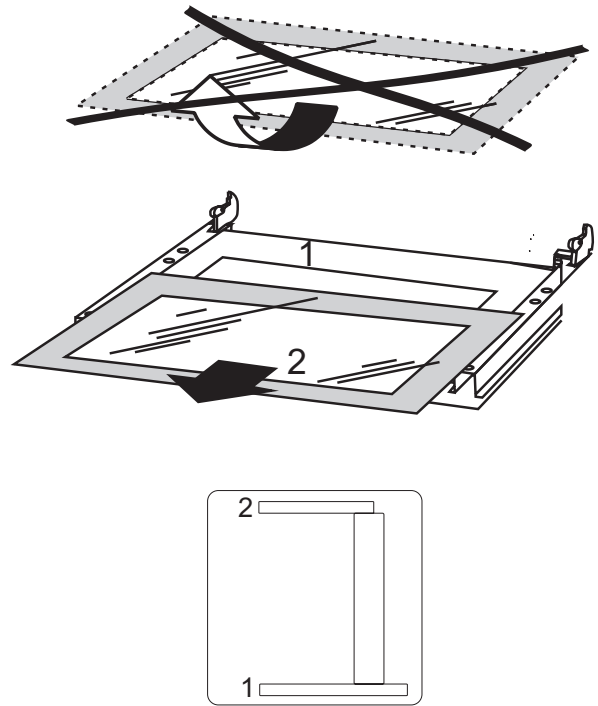

*Removal of the internal glass panel.
2 glass panel.*

CLEANING AND MAINTENANCE

▶ Regular inspections

Besides keeping the cooker clean, you should:

- carry out periodic inspections of the control elements and cooking units of the cooker. After the guarantee has expired you should have a technical inspection of the cooker carried out at a service centre at least once every two years,
- fix any operational faults,
- carry out periodical maintenance of the cooking units of the cooker.

Caution!

All repairs and regulatory activities should be carried out by the appropriate service centre or by an appropriately authorised fitter.

OPERATION IN CASE OF EMERGENCY

In the event of an emergency, you should:

- switch off all working units of the cooker
- disconnect the mains plug
- call the service centre
- some minor faults can be fixed by referring to the instructions given in the table below. Before calling the customer support centre or the service centre check the following points that are presented in the table.

PROBLEM	REASON	ACTION
1. The appliance does not work.	Break in power supply.	Check the household fuse box; if there is a blown fuse replace it with a new one.
2. The oven lighting does not work.	The bulb is loose or damaged.	Tighten up or replace the blown bulb (see ' <i>Cleaning and Maintenance</i> ').

TECHNICAL DATA

Electrical supply	220-240V ~50Hz
Maximum load	7,0 kW
Electric hob:	
2x14,5cm standard hotplate	1,0 kW
2x18cm standard hotplate	1,5 kW
Oven:	
bottom heater	1,1 kW
top heater	0,9 kW
grill	2,0 kW
Usable capacity of the oven*	65-72 litres
Energy rating	on the energy label
Cooker dimensions H/W/D	90 / 50 / 60 cm
Weight	approx. 40 kg
Complies with EU regulations	EN 60335-1, EN 60335-2-6 standards

* according to EN 50304
the capacity depends on the oven fittings – indicated on the energy label.

Certificate of compliance CE

The Manufacturer hereby declares that this product complies with the general requirements pursuant to the following European Directives:

- *The Low Voltage Directive 2006/95/EC,*
- *Electromagnetic Compatibility Directive 2004/108/EC,*
- *Directive on “Appliances Burning Gaseous Fuels” 2009/142/EC,*
- *Directive on ErP 2009/125/EC,*

*and therefore the product has been marked with the **CE** symbol and the **Declaration of Conformity** has been issued to the manufacturer and is available to the competent authorities regulating the market.*

Amica



Service Help Line

For the UK: please call **0844 815 8880**

For Ireland: please call **0818 46 46 46**

