

Lec

USER GUIDE

T5039W/B/S

Introduction

Thank you for buying this high quality appliance!

This handbook is designed to help you through each step of owning your new appliance, from installation, to use.

Please read through all of this guide carefully before you start using your appliance, as we have endeavoured to answer as many questions as possible, and provide you with as much support as we can.

If, however, you should find something missing, or not covered, please contact the Lec Customer Care team who will be only too happy to assist you on:

0844 815 3737

Our policy is one of constant development and improvement, therefore we cannot guarantee the strict accuracy of all of our illustrations and specifications changes may have been made subsequent to publishing.

Contents

For your safety	1
About your product	3
Installing your appliance.	4
Using your appliance	5
Care & cleaning	8
Troubleshooting.	9
Reversing the door.	10
Changing the plug	11

Disposal of old appliances

Before disposing of an old appliance, make sure that you have broken off, or disabled any locking mechanisms to prevent children becoming accidentally locked inside. Remove any plugs and power leads to ensure that the appliance is inoperative.



Please note: This symbol means that products bearing it may not be disposed of with household waste.

The refrigeration system contains insulating gases and refrigerant which will require specialist disposal. Most components can be recycled. Always contact your local council or authority for information regarding the correct disposal/removal of old appliances, do not dispose of with household waste.

Warning: When disposing of an old appliance make sure that the pipe work does not become damaged.

Packaging

All of the packaging supplied with your appliance can be recycled, or disposed of without any harm to the environment.

Cardboard may be crushed, or cut into smaller pieces if required for recycling or disposal. The polythene and polystyrene included contain no CFC's, and are environmentally friendly.

For further information on recycling, contact your local council or authority.

Before installing and using your new appliance

- Read through the instructions supplied with your appliance - failure to install or use this appliance in accordance with the instruction book may invalidate any warranty.
- The manufacturer does not accept any liability for damage caused through improper use, or incorrect installation.
- Do not install this appliance if it has been damaged during transportation. This includes the plug and power supply cord.
- Always install this appliance in line with these instructions.
- Always read these instructions fully before using the appliance for the first time.

- **Warning:** Do not allow the refrigerant circuit to become damaged while using or installing. Should it become damaged, do not use the appliance until you are instructed to do so by a service engineer. Refrigerant can ignite or cause damage to the eye when leaking.
- Always remember to unplug the appliance before cleaning. When disconnecting from the electricity supply, pull the plug, not the power cord.
- Do not use any electrical appliance inside the food storage area - unless they are recommended by the manufacturer.
- All electrical repairs must be carried out by a qualified electrician. Inadequate repairs may result in a major source of danger for the user and invalidate any warranty.
- Never store anything dangerous inside the appliance, such as combustibles, explosives, strong acid and alkali etc. Alcoholic beverages must be stored upright in an air tight container in the refrigerator. Never store alcohol in a freezer.
- When defrosting the appliance, never use sharp or pointed metal implements. Always use a plastic scraper. (see Defrosting for more information).
- Always keep any ventilation openings clear of obstruction. Should they become blocked, clear them straight away.
- Do not allow children to play, sit or hang onto any part of the appliance.
- This appliance is intended for domestic use only, for food refrigeration, food freezing and frozen food storage.
- Make sure that the plug is in an accessible place when installation is complete and remove all packaging.
- Only use this appliance for domestic purposes in accordance with these instructions.
- This appliance is not intended for use by persons (including children) with reduced physical, sensory or mental capabilities, or lack of experience and knowledge, unless they have been given supervision or instruction concerning use of the appliance by a person responsible for their safety.
- Refrigerating appliances might not operate consistently when sited for an extended period of time below the cold end of the the range of temperatures of the appliance.

About Your Product

Model Name:CE-BCD135-S

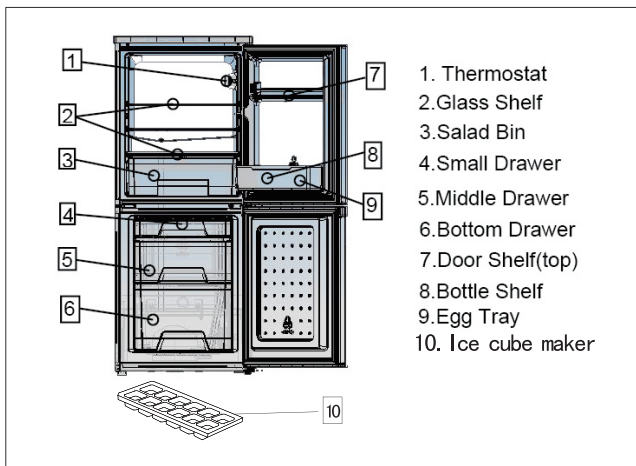

Technical Specification		
Appliance dimensions	Width (mm)	500
	Depth (mm)	540
	Height (mm)	1225
	Net volume of fresh food (litres)	90
	Net volume of freezer (litres)	45
	Energy Rating	A+
	Freezing capacity	2kg / 24hrs
	Climate Class	N,ST
	Noise (dB (A) re 1 pW)	42dBA
	Refrigerant type	R600a (50)

Climate Class	Ambient Temp. Range °C
SN	+10 to +32
N	+16 to +32
ST	+16 to +38
T	+16 to +43

This appliance operates at a voltage of:
220 - 240V ~ 50Hz

Before you start

- This appliance must stand vertically on a flat, even surface, to level the appliance use the leveling feet by turning them until the appliance is as level as possible. Do not install onto carpeted surfaces as this prevents adequate ventilation.
- Install the appliance in a well ventilated room. The appliance should not be placed near to any heat sources (cookers, heaters etc.) or in any unheated rooms (garages, outhouses etc.) as the ambient temperature affects the performance of the appliance.
- Do not expose the appliance to damp conditions, open air or rain.
- Do not lift the appliance by the pipes or the door when moving.

Should the appliance become damaged, contact Midea Customer Care and do not use the appliance until you are instructed to do so by a service engineer.

Installation clearances

- Allow 50mm clearance at the rear of the appliance and adequate clearance on each side of the appliance and over the top to ensure proper ventilation (see figures 1a) and use whichever dimensions suit your installation requirements best.

Getting started

Once you have installed your appliance in an appropriate location, follow the start up procedure below:

- Before you plug in the appliance, clean thoroughly the inside, and any accessories with warm water and bicarbonate of soda (0.5ml to 0.5 litres) and dry with a soft cloth.
- Leave the appliance to stand for 2 - 3 hours to allow the refrigerant to settle following installation and cleaning.

If the appliance has been transported horizontally, it must be left to stand vertically for 12 hours before installation.

- Once dry, plug the appliance into the socket.
- Turn the thermostat to the required setting - a medium setting is usually suitable.
- Leave the appliance for at least 4 hours before storing any food inside to allow a sufficient temperature to be reached.

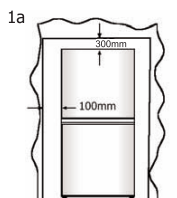

Total space required in use

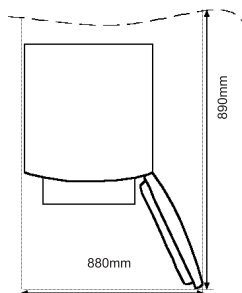

About the thermostat

- The thermostat is located in the upper rear part of the appliance.
- To reduce the temperature inside the appliance, turn the thermostat towards 6 maximum.
- To increase the temperature inside the appliance turn the thermostat towards 1 minimum.
- Depending on the ambient temperature of the room the appliance is in, you may need to adjust the thermostat accordingly.

CONDITION/REASON:	SETTING ADJUSTMENT:
REFRIGERATOR too cold Not set correctly for your conditions	Adjust TEMPERATURE Control one setting lower
REFRIGERATOR too warm Door opened often, large amount of food added or room temperature very warm	Adjust TEMPERATURE Control one setting higher
FREEZER too cold Not set correctly for your conditions	Adjust TEMPERATURE Control one setting lower
FREEZER too warm/too little ice Door opened often, or large amount of food added or very cold room temperature (can't cycle often enough) or heavy ice usage	Adjust TEMPERATURE Control one setting higher

In some cases food inside the refrigerator may become frozen, common causes of this are:

- Thermostat is set too high - you will need to adjust the setting to a more suitable temperature.
- The ambient temperature has dropped suddenly (i.e. during winter) and this makes the refrigerator even colder.

Making ice cubes

- Fill the ice cube tray 3/4 full with water and place into the freezer.
- Place the tray onto a level surface.
- To remove ice cubes, twist the tray or place under running water for a few seconds to loosen.
- Do not use sharp, pointed or metal implements to remove the ice cube tray if it becomes frozen to the fridge.

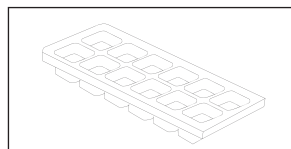

Tips for using this appliance

- Before storing cooked foods in the refrigerator, allow them to cool to room temperature.
- To maintain adequate air circulation, do not over fill the appliance. If there is too much food inside, the compressor does not work as effectively.
- Do not open the door any more than necessary - this will keep the temperature as cold as possible inside.
- When storing frozen food in the freezer, make sure that you follow the food manufacturers guidelines.
- Ices and water ices should not be consumed straight from the freezer - this can cause ice burns to the tongue and hands.
- Never touch the inside of the appliance, or any frozen items with wet hands. This can cause injury to your hands if they stick to cold surfaces.
- Wrap or cover foods well before storing. Always make sure that any packaging is air tight and suitable for use inside a fridge or freezer.
- Cooked meats and raw meats should be stored on separate shelves, and raw meat should not be allowed to drip onto other foods. Food which is to be frozen should not be in direct contact with already frozen food.
- You may hear gurgling noises or a humming sound while the appliance is in use and this is perfectly normal when the compressor is running and the coolant is moving through the system.
- A clicking sound may be heard, this is the thermostat and is normal.
- This appliance is designed to operate in an ambient temperature between 16 and 38 °C.
- Effervescent (fizzy) drinks should not be stored in the freezer or low temperature compartments.
- Do not exceed the storage times recommended by the food manufacturer and always check expiry dates.
- Smaller portions of fresh food freeze quicker than large portions. Divide large portions into smaller ones. This helps to preserve the nutrients and quality of the food.
- Always allow warm food to cool down before freezing it, preferably to room temperature.
- Before you store large amounts of food in the freezer, adjust the thermostat to the maximum (coldest) setting while the appliance freezes the food. After 24 hours, re-set the thermostat to the previous setting.
- Only thaw the amount of food you need, once food has been thawed cook it immediately.

Defrosting your appliance

The refrigerator defrosting process is carried out automatically everytime the compressor stops. The defrost water drains from the cabinet into a tray at the rear of the unit where it evaporates.

To defrost the freezer:

- Unplug the appliance and set the thermostat to the 'off' position.
- Leave the appliance to defrost. You can accelerate defrosting by placing a bowl of warm (not hot) water inside the appliance on a piece of cardboard.
- Do not use sharp, pointed or metal implements to scrap ice from the inside of the appliance. Use a plastic scraper.
- Do not use mechanical devices (hair dryer etc.) to accelerate the defrosting process.
- Once defrosting is completed, make sure that the inside of the appliance is dry and clean, plug in the appliance and switch the thermostat to the required temperature.

If there is any food in the appliance at the time of defrosting, remove it from the appliance wrap it well and store in a cool, dry place. Alternatively you can store it in a different freezer if possible.

In the event of a power cut

If the power failure is 3 hours or less, food can remain inside the appliance. Keep the door closed to maintain the temperature inside.

If the power cut is longer than 3 hours, remove all food, wrap well and store in a cool dry place.

Important: Be aware that the storage life of the food will have been reduced. Use up this food as soon as possible or discard. Do not re-freeze food which has thawed, either consume or cook and re-freeze if appropriate.

The drainage channel

The drainage channel collects water on the back wall of the refrigerator and ensures that it is drained away into a drip tray at the rear of the appliance.

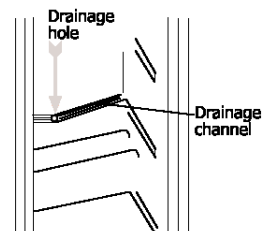

Before cleaning your appliance

You should always unplug this appliance before cleaning.

To clean your appliance

- Once defrosted, remove the accessories inside and clean the using warm water and a neutral detergent. Do not place them in a dishwasher.
- Clean the inside of the cabinet with warm water and a neutral detergent, do not use harsh abrasives or caustic cleaners.
- Dry the inside of the cabinet with a soft, dry cloth. Always make sure the inside of the appliance is dry after cleaning.
- Avoid getting water into the electric components of the appliance (i.e. the thermostat), or spilling water on the fridge.
- When cleaning the door seals, use only warm soapy water. Please use a mild soap and avoid damaging the door seal as this will affect the performance of your appliance.
- Clean the outside of the appliance with warm, soapy water and dry with a soft cloth. Any accumulation of dirt and dust should be removed from the back and bottom of the appliance to maintain adequate ventilation.
- If the appliance is not in use for a long period of time, you should defrost and clean the appliance as detailed. Make sure that it is dry, then unplug and leave the door open to prevent unpleasant smells inside.
- Clean the drainage channel regularly to prevent any build up of impurities. Use a damp clean cloth and wipe the channel clean, then use a pipe cleaner or similar flexible object to clean the drainage hole to prevent blockages.
- Unhook and clean the drip tray occasionally.

Please note: Regular turning off may shorten the life of this appliance.

Reversible door

The door may be reversed in order to make installation more convenient.

We recommend that two people reverse the door, as the appliance requires supporting whilst being tipped. Take care when fitting and tightening screws.

- Remove the cover (1) and the top hinge (2)
- Lift the top door upwards to disengage it from the middle hinge. Put the door to one side, laying it carefully down on a padded surface.
- Using a screwdriver, dismantle the middle hinge. Lift the freezer door upwards to disengage it from the lower hinge. Put the door to one side, laying it carefully down on a padded surface.
- Swap over the position of the lower hinge and the adjustable leg to the other side of the cabinet.
- Remove the hinge pin that is in the bottom of the fridge and freezer door. On the other side of the fridge and freezer door, insert the replacement hinge pin that is supplied with the appliance.
- Place the freezer door on the lower hinge, making sure that the hinge pin is inserted into the hole in the bottom of the freezer door. Put the middle hinge back on the cabinet, making sure that it is on the opposite side from its original position.
- Place the fridge door on the middle hinge, making sure that the hinge pin is inserted into the hole in the bottom of the fridge door. Shut the door and then replace the top hinge. Ensure that the top hinge pin is inserted in the hole at the top of the fridge door. Replace the covers.

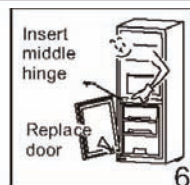
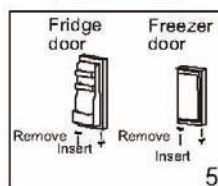
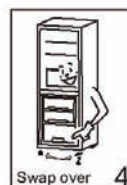

Changing the bulb

- Pull the lamp forwards to gain access to the lamp holder. Unscrew the light bulb in an anti clockwise direction by the holder. Replace the bulb with one of the correct size and type (15 watt, SES E14 base). Replace the lamp cover by pushing the cover backwards along the grooves. Reconnect the appliance to the electricity supply.

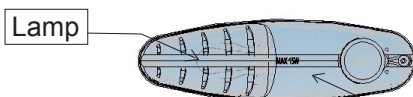

Lamp Cover

Any electrical work required to install this appliance should be carried out by a qualified electrician or competent person.

This appliance must be earthed. The manufacturer declines any liability should these safety measures not be observed.

Electrical Requirements

Before switching on, make sure the electricity supply voltage is the same as that indicated on the appliance rating plate. The appliance is supplied with a 13 amp plug fitted. In the event of having to change the fuse in the plug supplied, a 13 amp ASTA approved (BS 1362) fuse must be used. Should the plug need to be replaced for any reason. The wires in the mains lead are coloured in accordance with the following code:

Green and Yellow: Earth

Blue: Neutral

Brown: Live

The wire coloured green and yellow must be connected to the terminal marked with the letter "E" or by the earth symbol  or coloured green and yellow. The wire coloured blue must be connected to the terminal "N". The wire coloured brown must be connected to the terminal marked "L".

Upon completion there must be no cut, or stray strands of wire present and the cord clamp must be secure over the outer sheath.

Important!

The plug must still be accessible after the appliance has been installed. The appliance should not be connected to the electrical supply by means of an extension cable. In case that the electrical cable has to be replaced, please contact the Customer Care Centre and arrange a service engineers visit.

Warning!

A cut off plug inserted into a 13 amp socket is a serious safety (shock) hazard. Ensure that it is disposed of safely.

This appliance complies with the following E.E.C. Directives: 2006/95/EC (Low Voltage Directive) and subsequent modifications, 2004/108/EC (Electromagnetic Compatibility Directive) and subsequent modifications.

Note: Figures in the user manual are only for reference.
The actual product may differ slightly.

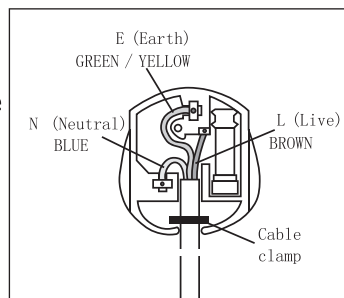

The wires in the mains lead are coloured in accordance with the following code:

Green and Yellow = Earth
Blue = Neutral
Brown = Live

Service Record

Please record your model number and serial number in the space below. Having these numbers to hand will help us to help you, quickly and more efficiently.

When contacting us, please use the Customer Care number on the back cover of this handbook

Model Number										
Serial Number										

Date of purchase	Installers stamp / Printed name	Date of installation
Place of purchase:		

Date	Part(s) replaced	Engineers Stamp/ Printed Name

Lec

Lec Refrigeration

Stoney Lane, Prescot, Merseyside, L35 2XW

Customer Care Centre: 0844 815 3737

www.lec.co.uk

Lec Refrigeration, a division of Glen Dimplex Home Appliances